

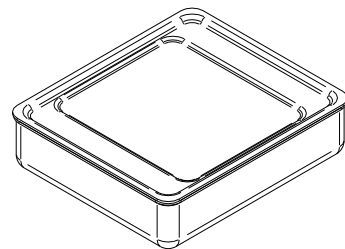

B-B

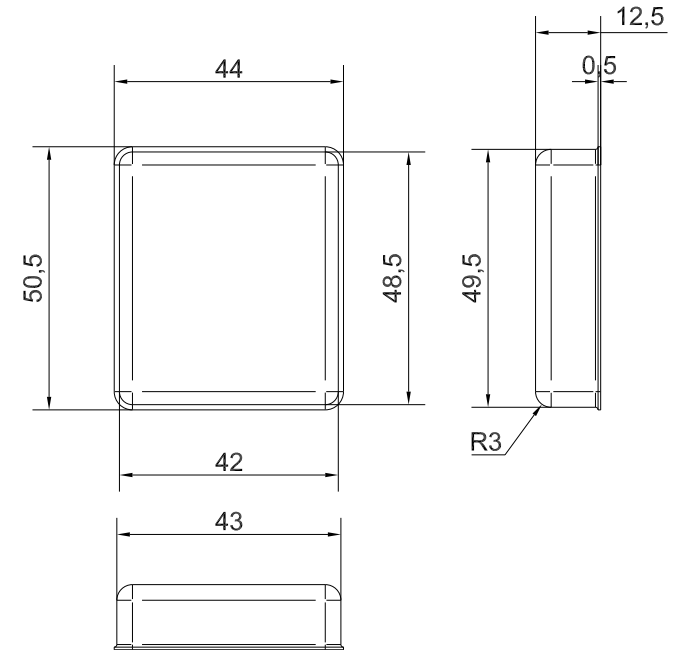
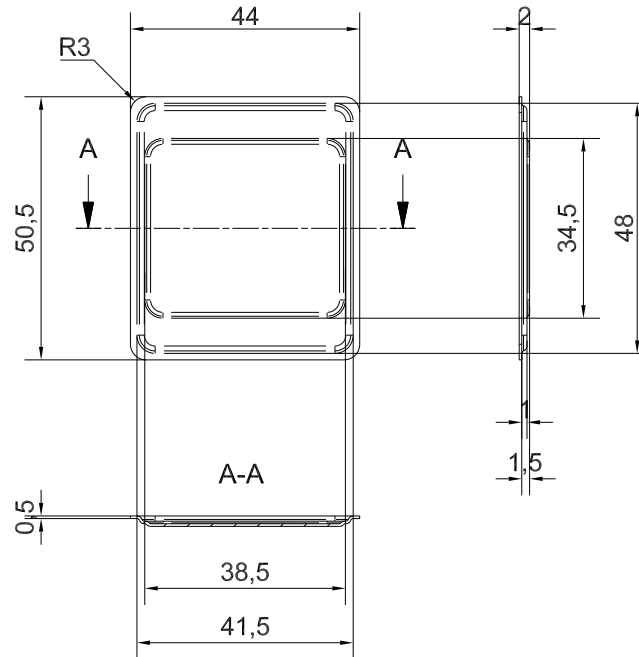
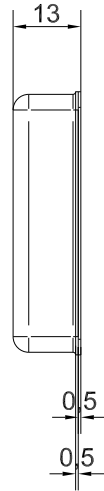
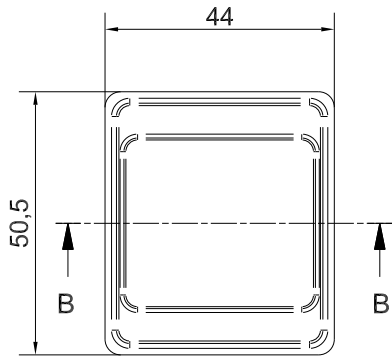
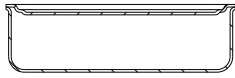
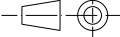

	Denomination	Assembly 445		Part. Number	445
	Subject to technical modification without prior notice. Tipographical and other errors do not justify any claim for damages. All dimensions should be verified using an actual moulded part.		Rev. Index	Scale	
	This document contains proprietary information of TEKO S.p.a. and is tendered subject to the conditions that the information be retained in confidence not be reproduced or copied and not be used or incorporated in any product.		Date	18/11/2005	Format design
					A3